

MOUNTING INSTRUCTIONS

6863 安裝說明

- 1.) Use **Bracket** as template to locate appropriate drilling centers with pencil.
使用固定鐵片和鉛筆在預定鑽孔的位置,畫上記號.
- 2.) Use 6mm drilling bit to drill holes in your marked locations, when mounting on drywall, insert **Plastic Anchors**.
當安裝在水泥牆,使用1/4英寸鑽頭,鑽孔深度4公分,嵌入塑膠塞並使之齊平於牆面.
- 3.) Attach **Bracket** to wall with **Wall Screws**.
將固定鐵片以螺絲鎖在牆面上.
- 4.) Locate the **Main Part** on the **Bracket** and secure with **Set Screw**.
在固定鐵片上面掛住產品本體,並以螺絲起子由下方鎖緊埋頭螺絲,完成安裝程序.

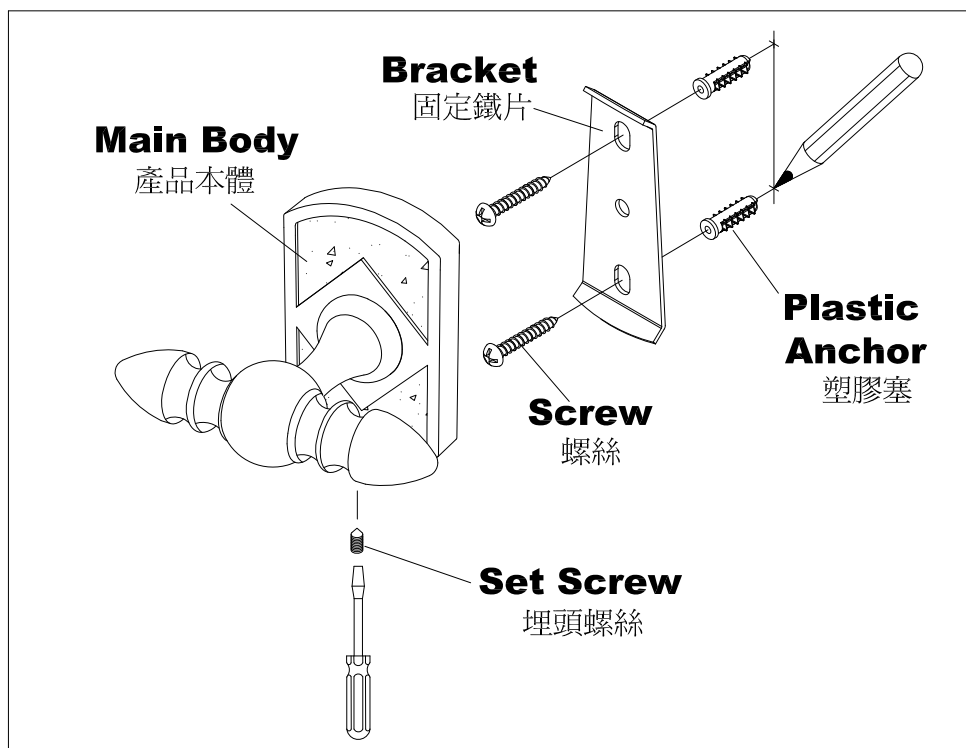

6863 SERIES:

